

PO NTIA NA

FILIPPO MAMBRETTI

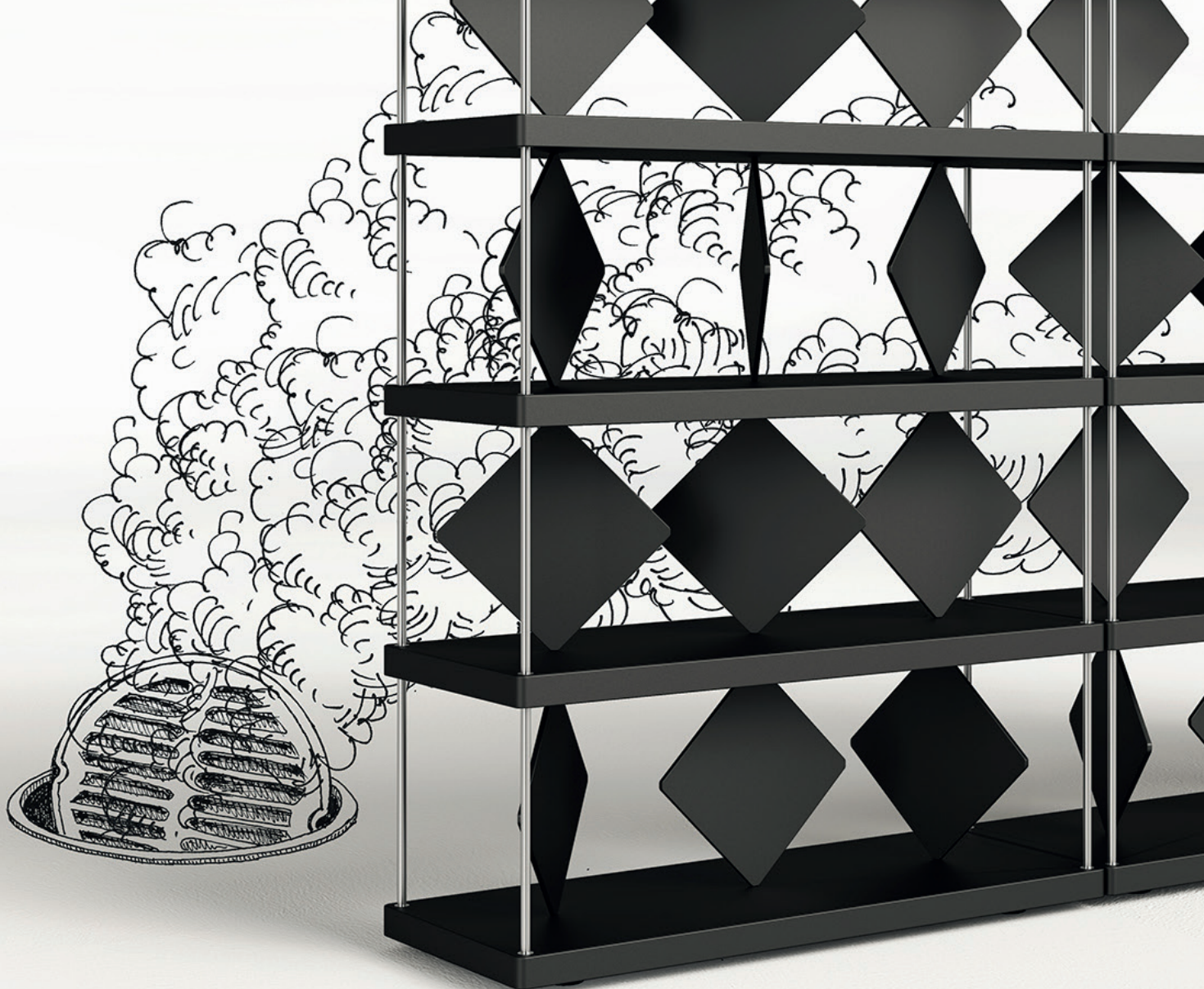

Libreria autoportante in agglomerato di legno caratterizzata da rombi girevoli, tiranti in metallo cromato.
I rombi sui ripiani si possono agevolmente rimuovere e successivamente riposizionare (senza l'utilizzo di attrezzi).
Finitura gofrata nei colori a campionario. Ripiani e rombi possono avere colori diversi.

Free-standing bookcase in composite wood characterized by revolving rhombus, rods in chromed metal.

The rhombus pieces on the shelves can be easily removed and then placed (without using tools).

Embossed finishing in all colours of our sample catalogue, shelves and rhombus can have different colours.



0,85



2





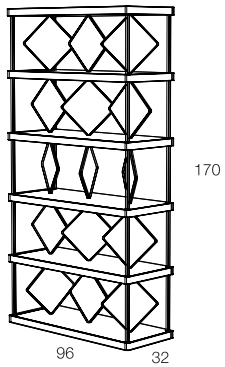

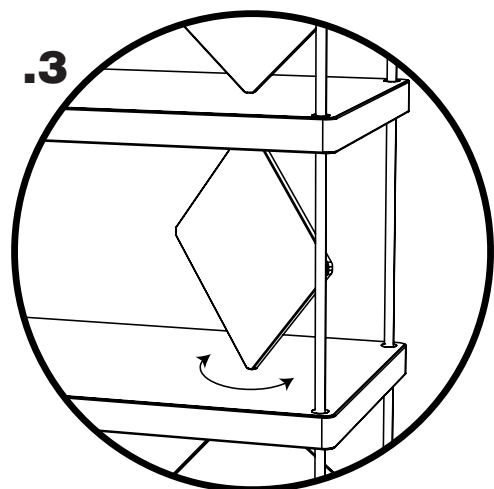
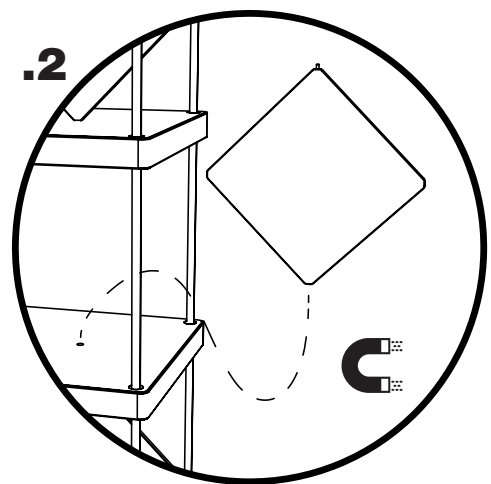
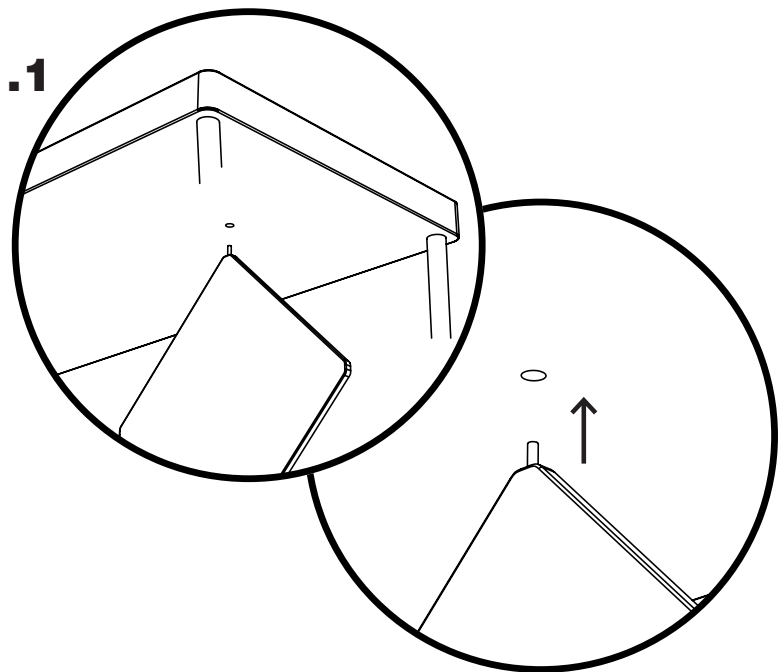
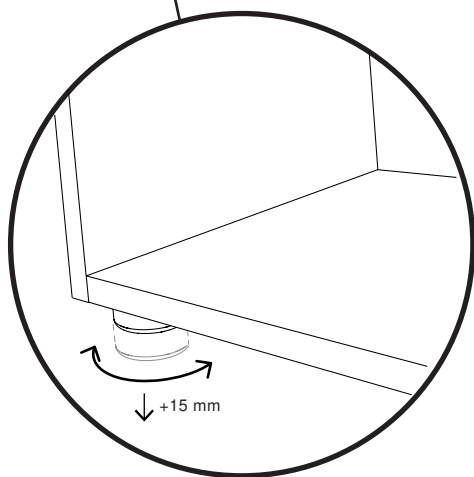
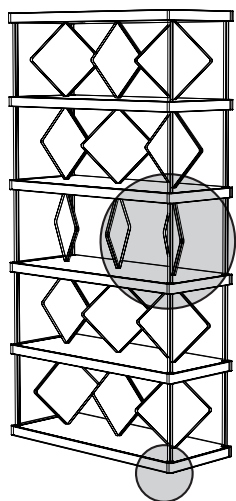

























50





DA TI TE CNI CI TE CH NIC AL DA TA

	LACCATURA GOFFRATA NEI COLORI A CAMPIONARIO		TEAK OPACO / MDF NERO
	FOGLIA ORO		CEMENTO BIANCO
	FOGLIA ARGENTO		CEMENTO GRIGIO
	OTTONE LUCIDO		LED LUCE BIANCA CALDA / FREDDA (3000/6000 K)
	NICHEL LUCIDO		LED LUCE CALDA 4 CANALI (RGB WW)
	OTTONE SATINATO		MODULO DESTRO / SINISTRO
	NICHEL SATINATO		FISSAGGIO A PARETE
	INOX		ASSEMBLARE
	METALLO BIANCO GOFFRATO		RIPIANO SPOSTABILE
	METALLO ANTRACITE GOFFRATO		RIPIANO FISSO
	METALLO BIANCO OPACO		VOLUME
	NICHEL NERO		NUMERO DI COLLI
	SPECCHIO STANDARD		PESO
	SPECCHIO BRONZATO		
	SPECCHIO FUME'		
	APERTURA VASISTAS / RIBALTA		
	APERTURA DESTRA / SINISTRA		
	RIPIANO IN CRISTALLO EXTRA CHIARO		
	ESSENZA LARICE SPAZZOLATO / FINITURA LACCATO GOFFRATO NEI COLORI A CAMPIONARIO		

A.
D.
&
GRA
PH
ICS

STUDIO14

minottiitalia

ADION S.R.L.
VIALE REPUBBLICA, 140
22060 – CABIATE – COMO
+39 031 769 251
INFO@MINOTTIITALIA.IT
WWW.MINOTTIITALIA.IT