

AN
G
CLAUDIO BITETTI

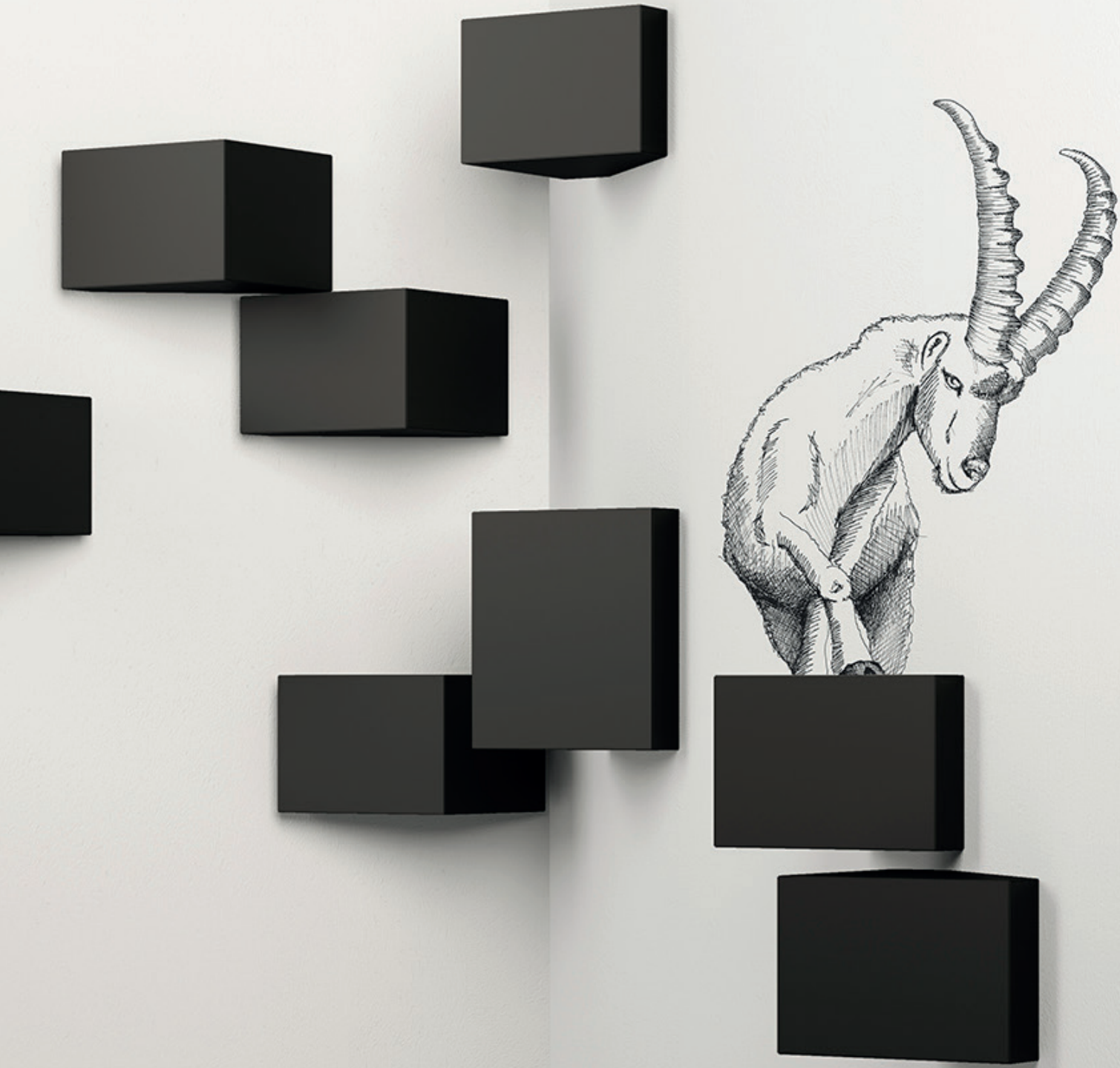

minottiitalia

Contenitore pensile pentagonale, ideato per composizioni angolari, in agglomerato di legno con anta battente.
Finitura gofrata nei colori a campionario.

*Pentagonal wall case, designed for corner compositions, in composite wood with hinged door.
Embossed finishing in all colours of our sample catalogue.*



ANG 39

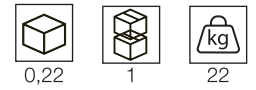
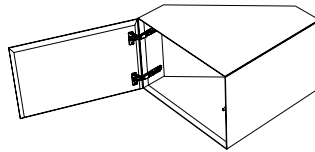
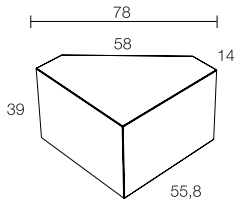



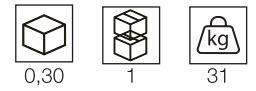
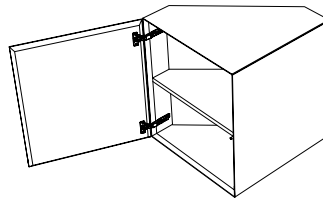
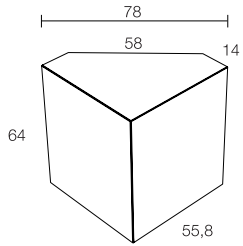

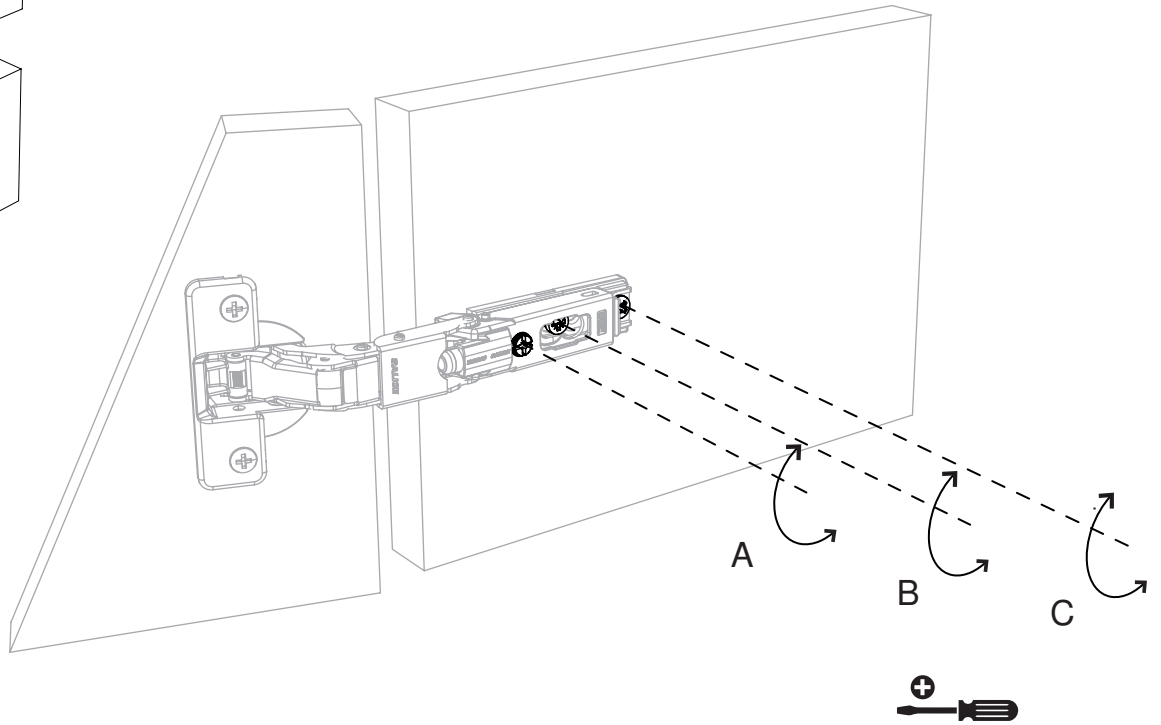
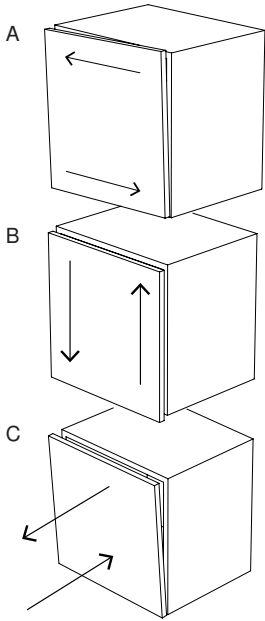
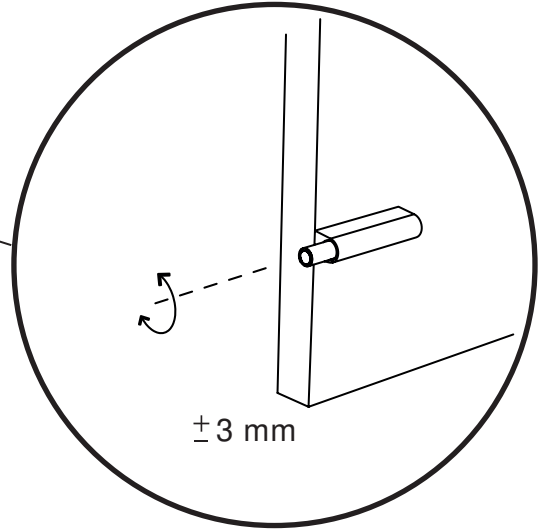
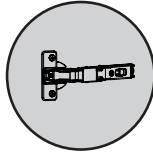
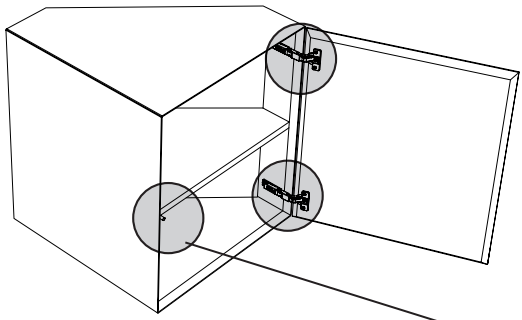

























ANG 64





DA TI TE CNI CI TE CH NIC AL DA TA

	LACCATURA GOFFRATA NEI COLORI A CAMPIONARIO		TEAK OPACO / MDF NERO
	FOGLIA ORO		CEMENTO BIANCO
	FOGLIA ARGENTO		CEMENTO GRIGIO
	OTTONE LUCIDO		LED LUCE BIANCA CALDA / FREDDA (3000/6000 K)
	NICHEL LUCIDO		LED LUCE CALDA 4 CANALI (RGB WW)
	OTTONE SATINATO		MODULO DESTRO / SINISTRO
	NICHEL SATINATO		FISSAGGIO A PARETE
	INOX		ASSEMBLARE
	METALLO BIANCO GOFFRATO		RIPIANO SPOSTABILE
	METALLO ANTRACITE GOFFRATO		RIPIANO FISSO
	METALLO BIANCO OPACO		VOLUME
	NICHEL NERO		NUMERO DI COLLI
	SPECCHIO STANDARD		PESO
	SPECCHIO BRONZATO		
	SPECCHIO FUME'		
	APERTURA VASISTAS / RIBALTA		
	APERTURA DESTRA / SINISTRA		
	RIPIANO IN CRISTALLO EXTRA CHIARO		
	ESSENZA LARICE SPAZZOLATO / FINITURA LACCATO GOFFRATO NEI COLORI A CAMPIONARIO		

A.
D.
&
GRA
PH
ICS

STUDIO14

minottiitalia

ADION S.R.L.
VIALE REPUBBLICA, 140
22060 – CABIATE – COMO
+39 031 769 251
INFO@MINOTTIITALIA.IT
WWW.MINOTTIITALIA.IT